

Opomba: vse mere preveriti ma licu mesta!

D1 kos 1

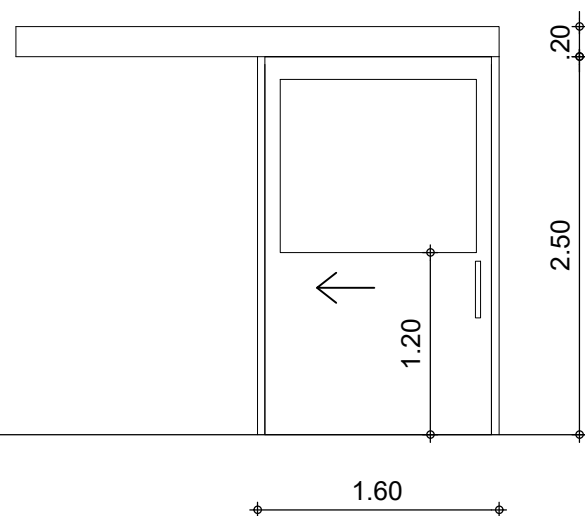

D1a kos 1

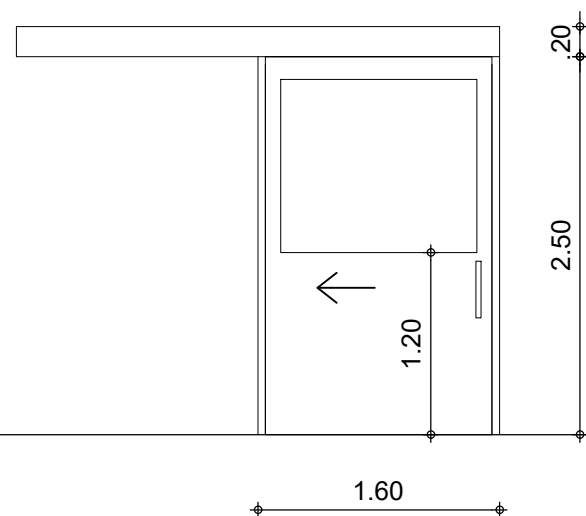

D2a kos 1

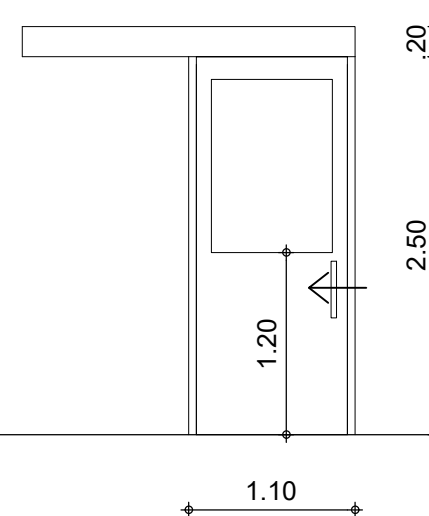

D3 kos 2

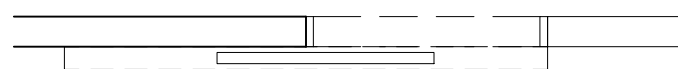
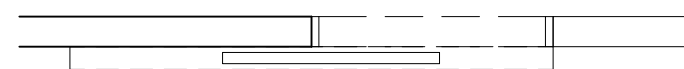
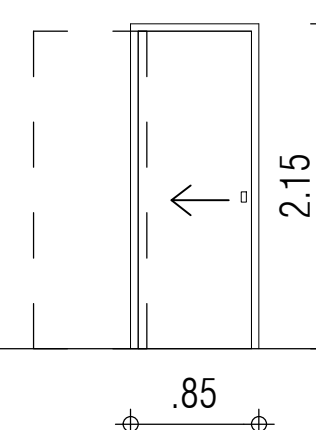

V1 kos 1

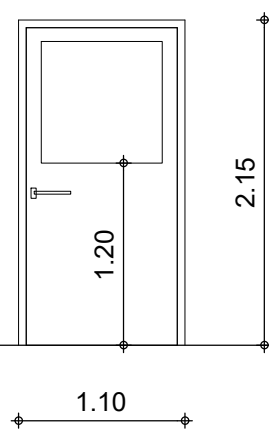

V1.a kos 2

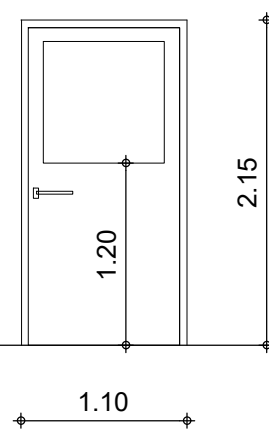

V2 kos 1

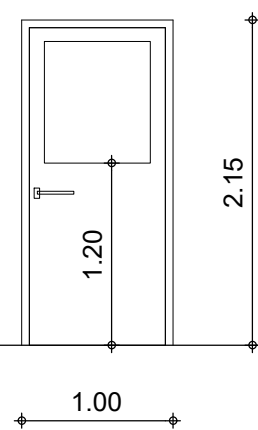

alu 1 kos 1

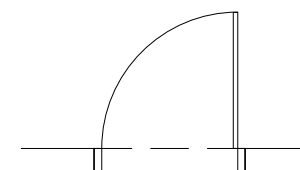
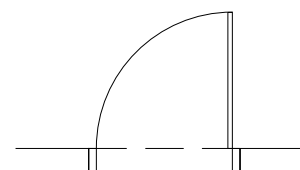
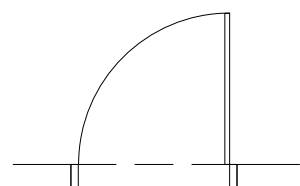
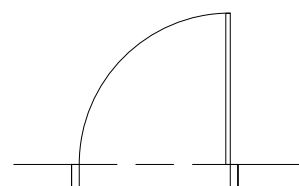
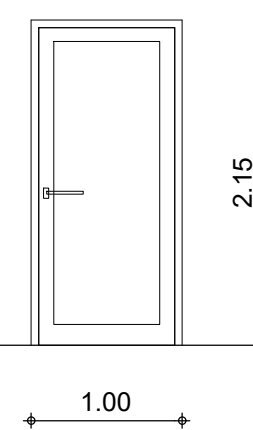

**STUDIO GALEB d.o.o., Muzejski trg 4, Koper**

INVESTITOR	ORTOPEDSKA BOLNIŠNICA VALDOLTRA Jadranska cesta 31, 6280 Ankaran		
OBJEKT	REKONSTRUKCIJA OBJEKTA LEKARNE, LABORATORIJA IN PEDAGOŠKIH PROSTOROV V ORTOPEDSKI BOLNIŠNICI VALDOLTRA (parcelna št. 842 k.o. Oltra)		
PROJEKT	PZI		
ZA GRADNJO	REKONSTRUKCIJA		
NAČRT	ARHITEKTURA		
DEL NAČRTA	NOVO STANJE-SHEMA NOTRANJNH VRAT		
ODGOVORNI PROJE.	ALEKSANDER BIZJAK udia		
SPREMEMBA			
ŠT.NAČRTA	DATUM	MERILO	ŠT.LISTA
01-18	OKTOBER 2018	1 : 50	10